

NTR4502P

Power MOSFET

-30 V, -1.95 A, Single, P-Channel, SOT-23

Features

- Leading Planar Technology for Low Gate Charge / Fast Switching
- Low $R_{DS(on)}$ for Low Conduction Losses
- SOT-23 Surface Mount for Small Footprint (3 X 3 mm)
- Pb-Free Packages are Available

Applications

- DC to DC Conversion
- Load/Power Switch for Portables and Computing
- Motherboard, Notebooks, Camcorders, Digital Camera's, etc.
- Battery Charging Circuits

MAXIMUM RATINGS ($T_J = 25^\circ\text{C}$ unless otherwise stated)

Parameter	Symbol	Value	Unit	
Drain-to-Source Voltage	V_{DS}	-30	V	
Gate-to-Source Voltage	V_{GS}	± 20	V	
Drain Current (Note 1)	$t < 10$ s	$T_A = 25^\circ\text{C}$	I_D -1.95	A
		$T_A = 70^\circ\text{C}$		-1.56
Power Dissipation (Note 1)	$t < 10$ s	P_D	1.25	W
Continuous Drain Current (Note 1)	Steady State	$T_A = 25^\circ\text{C}$	I_D -1.13	A
		$T_A = 70^\circ\text{C}$		-0.90
Power Dissipation (Note 1)	Steady State	P_D	0.4	W
Pulsed Drain Current	$t_p = 10$ μs	I_{DM}	-6.8	A
Operating Junction and Storage Temperature	T_J	-55 to 150	$^\circ\text{C}$	
	T_{STG}			
Source Current (Body Diode)	I_S	-1.25	A	
Lead Temperature for Soldering Purposes (1/8 in from case for 10 s)	T_L	260	$^\circ\text{C}$	

THERMAL RESISTANCE RATINGS

Parameter	Symbol	Max	Unit
Junction-to-Ambient - Steady State (Note 1)	$R_{\theta JA}$	300	$^\circ\text{C}/\text{W}$
Junction-to-Ambient - $t = 10$ s (Note 1)	$R_{\theta JA}$	100	

Stresses exceeding Maximum Ratings may damage the device. Maximum Ratings are stress ratings only. Functional operation above the Recommended Operating Conditions is not implied. Extended exposure to stresses above the Recommended Operating Conditions may affect device reliability.

1. Surface-mounted on FR4 board using 1 in sq. pad size (Cu area = 1.127 in sq. [1 oz] including traces).



ON Semiconductor®

<http://onsemi.com>

$V_{(BR)DSS}$	$R_{DS(on)}$ TYP	I_D Max (Note 1)
-30 V	155 m Ω @ -10 V	-1.95 A
	240 m Ω @ -4.5 V	

P-Channel MOSFET

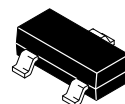
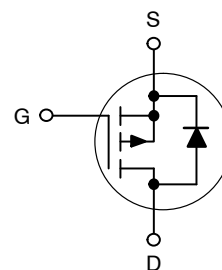

SOT-23
CASE 318
STYLE 21

MARKING DIAGRAM/ PIN ASSIGNMENT

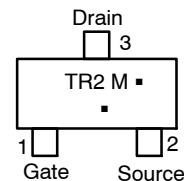

TR2 = Device Code
M = Date Code*
▪ = Pb-Free Package

(Note: Microdot may be in either location)

*Date Code orientation and/or overbar may vary depending upon manufacturing location.

ORDERING INFORMATION

Device	Package	Shipping†
NTR4502PT1	SOT-23	3000 / Tape & Reel
NTR4502PT1G	SOT-23 (Pb-Free)	3000 / Tape & Reel
NTR4502PT3	SOT-23	10000 / Tape & Reel
NTR4502PT3G	SOT-23 (Pb-Free)	10000 / Tape & Reel

†For information on tape and reel specifications, including part orientation and tape sizes, please refer to our Tape and Reel Packaging Specifications Brochure, BRD8011/D.

NTR4502P

Electrical Characteristics ($T_J = 25^\circ\text{C}$ unless otherwise specified)

Parameter	Symbol	Test Condition	Min	Typ	Max	Unit
-----------	--------	----------------	-----	-----	-----	------

OFF CHARACTERISTICS

Drain-to-Source Breakdown Voltage	$V_{(BR)DSS}$	$V_{GS} = 0\text{ V}, I_D = -250\ \mu\text{A}$	-30			V
Zero Gate Voltage Drain Current	I_{DSS}	$V_{GS} = 0\text{ V}, V_{DS} = -30\text{ V}$	$T_J = 25^\circ\text{C}$		-1	μA
			$T_J = 55^\circ\text{C}$		-10	
Gate-to-Source Leakage Current	I_{GSS}	$V_{DS} = 0\text{ V}, V_{GS} = \pm 20\text{ V}$			± 100	nA

ON CHARACTERISTICS (Note 3)

Gate Threshold Voltage	$V_{GS(TH)}$	$V_{GS} = V_{DS}, I_D = -250\ \mu\text{A}$	-1.0		-3.0	V
Drain-to-Source On Resistance	$R_{DS(on)}$	$V_{GS} = -10\text{ V}, I_D = -1.95\text{ A}$		155	200	m Ω
		$V_{GS} = -4.5\text{ V}, I_D = -1.5\text{ A}$		240	350	
Forward Transconductance	g_{FS}	$V_{DS} = -10\text{ V}, I_D = -1.25\text{ A}$		3		S

CHARGES AND CAPACITANCES

Input Capacitance	C_{ISS}	$V_{GS} = 0\text{ V}, f = 1\text{ MHz}, V_{DS} = -15\text{ V}$		200		pF
Output Capacitance	C_{OSS}			80		
Reverse Transfer Capacitance	C_{RSS}			50		
Total Gate Charge	$Q_{G(TOT)}$	$V_{GS} = -10\text{ V}, V_{DS} = -15\text{ V}; I_D = -1.95\text{ A}$		6	10	nC
Threshold Gate Charge	$Q_{G(TH)}$			0.3		
Gate-to-Source Charge	Q_{GS}			1		
Gate-to-Drain Charge	Q_{GD}			1.7		

SWITCHING CHARACTERISTICS (Note 4)

Turn-On Delay Time	$t_{d(ON)}$	$V_{GS} = -10\text{ V}, V_{DD} = -15\text{ V}, I_D = -1.95\text{ A}, R_G = 6\ \Omega$		5.2	10	ns
Rise Time	t_r			12	20	
Turn-Off Delay Time	$t_{d(OFF)}$			19	35	
Fall Time	t_f			17.5	30	

DRAIN-SOURCE DIODE CHARACTERISTICS (Note 3)

Forward Diode Voltage	V_{SD}	$V_{GS} = 0\text{ V}, I_S = -1.25\text{ A}$		-0.8	-1.2	V
Reverse Recovery Time	t_{RR}	$V_{GS} = 0\text{ V}, dI_{SD}/dt = 100\text{ A}/\mu\text{s}, I_S = -1.25\text{ A}$		23		ns

2. Surface-mounted on FR4 board using 1 in sq. pad size (Cu area = 1.127 in sq. [1 oz] including traces).
3. Pulse Test: pulse width $\leq 300\ \mu\text{s}$, duty cycle $\leq 2\%$.
4. Switching characteristics are independent of operating junction temperatures.

NTR4502P

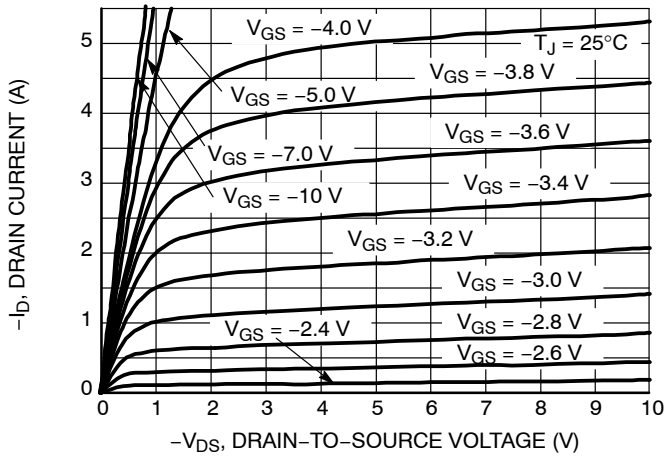

Figure 1. On-Region Characteristics

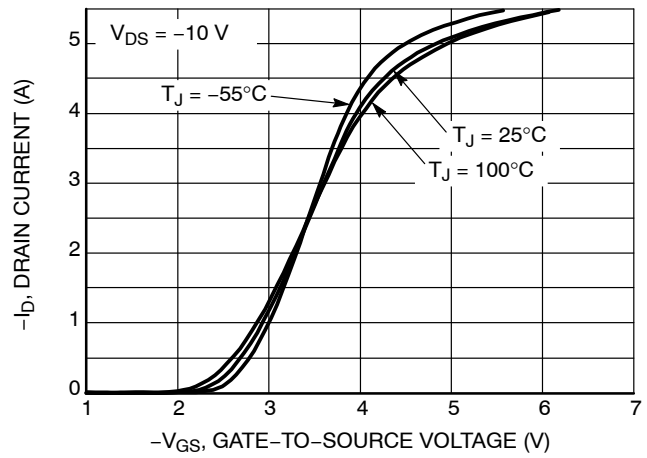

Figure 2. Transfer Characteristics

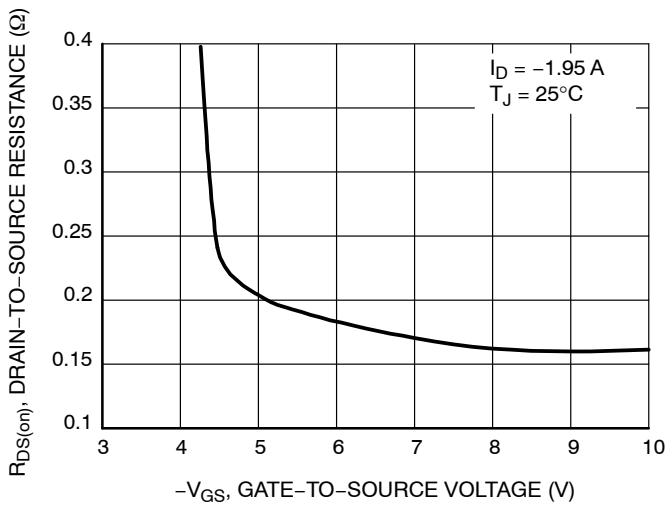

Figure 3. On-Resistance versus Gate-to-Source Voltage

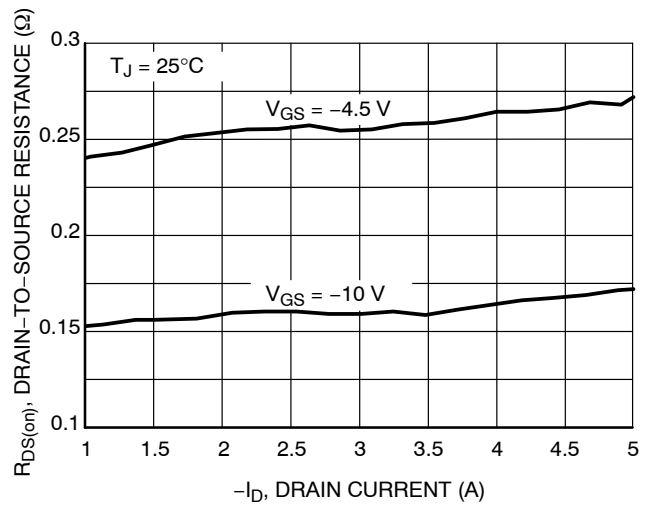

Figure 4. On-Resistance versus Drain Current and Gate Voltage

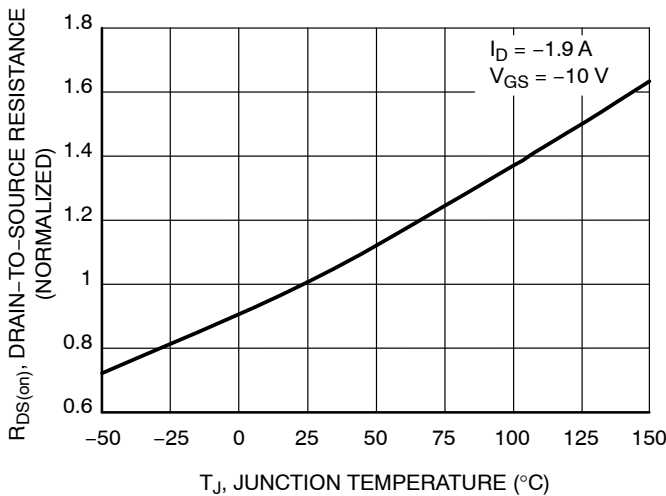

Figure 5. On-Resistance Variation with Temperature

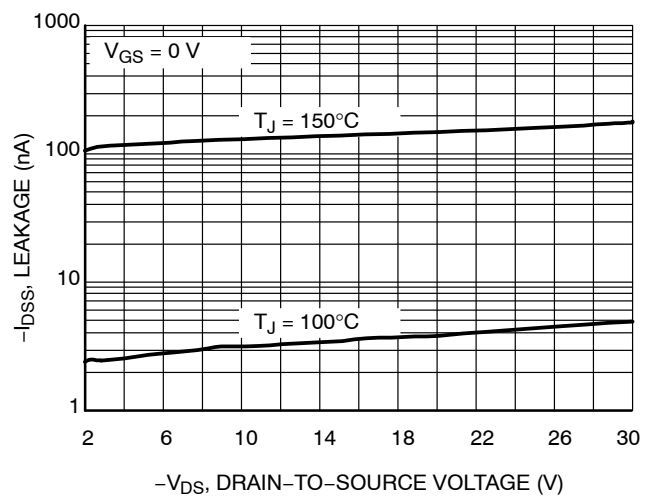

Figure 6. Drain-to-Source Leakage Current versus Voltage

NTR4502P

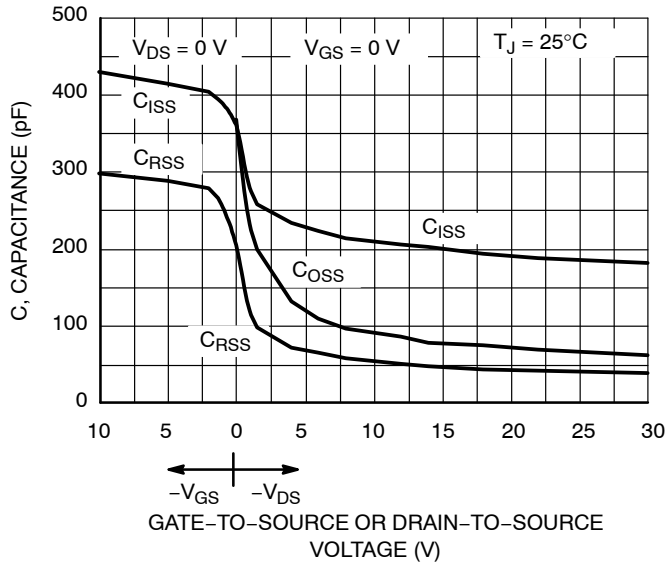

Figure 7. Capacitance Variation

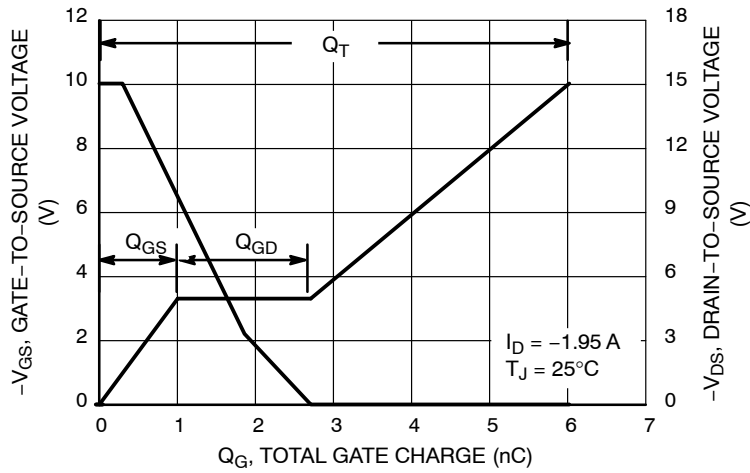

Figure 8. Gate-to-Source and Drain-to-Source Voltage versus Total Charge

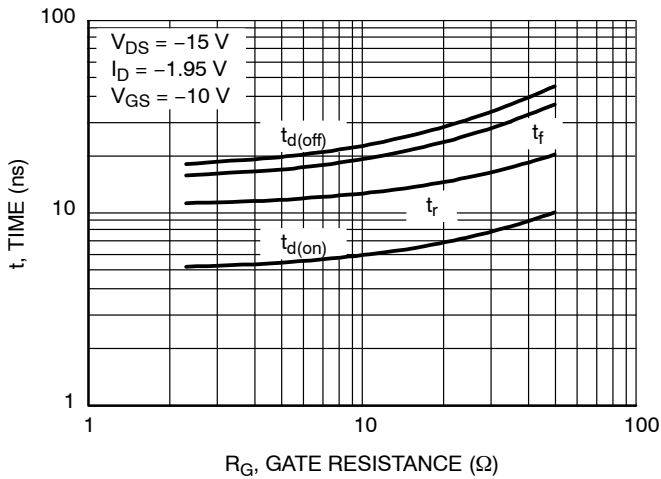

Figure 9. Resistive Switching Time Variation versus Gate Resistance

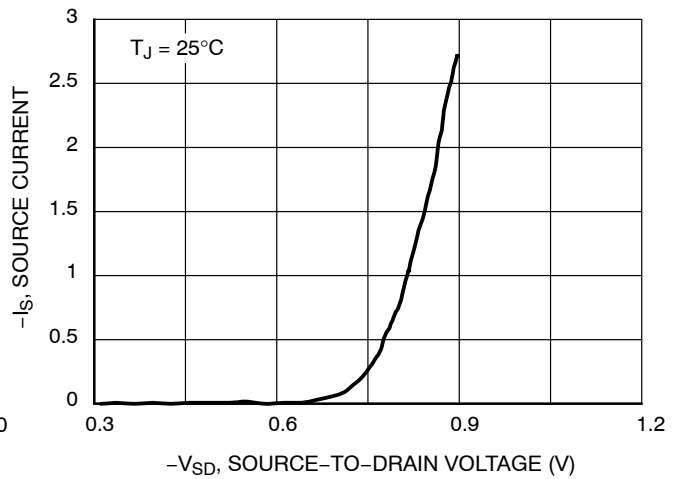
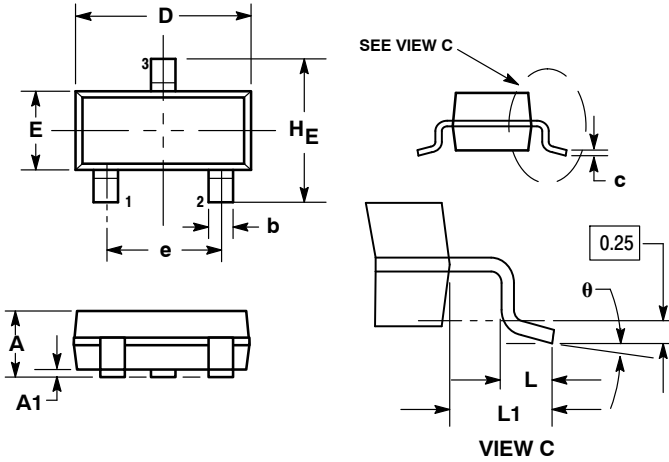

Figure 10. Diode Forward Voltage versus Current

NTR4502P

PACKAGE DIMENSIONS

SOT-23 (TO-236)
CASE 318-08
ISSUE AN



NOTES:

1. DIMENSIONING AND TOLERANCING PER ANSI Y14.5M, 1982.
2. CONTROLLING DIMENSION: INCH.
3. MAXIMUM LEAD THICKNESS INCLUDES LEAD FINISH THICKNESS. MINIMUM LEAD THICKNESS IS THE MINIMUM THICKNESS OF BASE MATERIAL.
4. 318-01 THRU -07 AND -09 OBSOLETE, NEW STANDARD 318-08.

DIM	MILLIMETERS			INCHES		
	MIN	NOM	MAX	MIN	NOM	MAX
A	0.89	1.00	1.11	0.035	0.040	0.044
A1	0.01	0.06	0.10	0.001	0.002	0.004
b	0.37	0.44	0.50	0.015	0.018	0.020
c	0.09	0.13	0.18	0.003	0.005	0.007
D	2.80	2.90	3.04	0.110	0.114	0.120
E	1.20	1.30	1.40	0.047	0.051	0.055
e	1.78	1.90	2.04	0.070	0.075	0.081
L	0.10	0.20	0.30	0.004	0.008	0.012
L1	0.35	0.54	0.69	0.014	0.021	0.029
HE	2.10	2.40	2.64	0.083	0.094	0.104

STYLE 1:

1. GATE
2. SOURCE
3. DRAIN

SOLDERING FOOTPRINT*

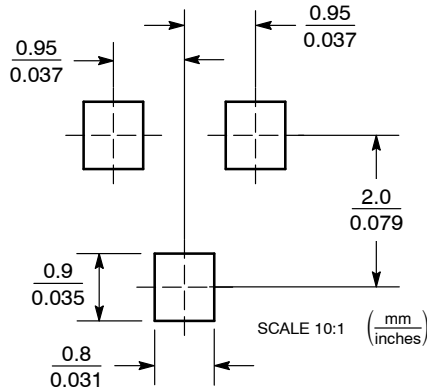

*For additional information on our Pb-Free strategy and soldering details, please download the ON Semiconductor Soldering and Mounting Techniques Reference Manual, SOLDERRM/D.

ON Semiconductor and are registered trademarks of Semiconductor Components Industries, LLC (SCILLC). SCILLC reserves the right to make changes without further notice to any products herein. SCILLC makes no warranty, representation or guarantee regarding the suitability of its products for any particular purpose, nor does SCILLC assume any liability arising out of the application or use of any product or circuit, and specifically disclaims any and all liability, including without limitation special, consequential or incidental damages. "Typical" parameters which may be provided in SCILLC data sheets and/or specifications can and do vary in different applications and actual performance may vary over time. All operating parameters, including "Typicals" must be validated for each customer application by customer's technical experts. SCILLC does not convey any license under its patent rights nor the rights of others. SCILLC products are not designed, intended, or authorized for use as components in systems intended for surgical implant into the body, or other applications intended to support or sustain life, or for any other application in which the failure of the SCILLC product could create a situation where personal injury or death may occur. Should Buyer purchase or use SCILLC products for any such unintended or unauthorized application, Buyer shall indemnify and hold SCILLC and its officers, employees, subsidiaries, affiliates, and distributors harmless against all claims, costs, damages, and expenses, and reasonable attorney fees arising out of, directly or indirectly, any claim of personal injury or death associated with such unintended or unauthorized use, even if such claim alleges that SCILLC was negligent regarding the design or manufacture of the part. SCILLC is an Equal Opportunity/Affirmative Action Employer. This literature is subject to all applicable copyright laws and is not for resale in any manner.

PUBLICATION ORDERING INFORMATION

LITERATURE FULFILLMENT:
Literature Distribution Center for ON Semiconductor
P.O. Box 5163, Denver, Colorado 80217 USA
Phone: 303-675-2175 or 800-344-3860 Toll Free USA/Canada
Fax: 303-675-2176 or 800-344-3867 Toll Free USA/Canada
Email: orderlit@onsemi.com

N. American Technical Support: 800-282-9855 Toll Free
USA/Canada
Europe, Middle East and Africa Technical Support:
Phone: 421 33 790 2910
Japan Customer Focus Center
Phone: 81-3-5773-3850

ON Semiconductor Website: www.onsemi.com
Order Literature: <http://www.onsemi.com/orderlit>
For additional information, please contact your local
Sales Representative